

FLUKE®

87

True RMS Multimeter

Users Manual

Interference Information

This equipment generates and uses radio frequency energy and if not installed and used in strict accordance with the manufacturer's instructions, may cause interference to radio and television reception. It has been type tested and found to comply with the limits for a Class B computing device in accordance with the specifications of Part 15 of FCC Rules, which are designed to provide reasonable protection against such interference in a residential installation.

Operation is subject to the following two conditions:



- This device may not cause harmful interference.
- This device must accept any interference received, including interference that may cause undesired operation.

There is no guarantee that interference will not occur in a particular installation. If this equipment does cause interference to radio or television reception, which can be determined by turning the equipment off and on, the user is encouraged to try to correct the interference by one of more of the following measures:

- Reorient the receiving antenna
- Relocate the equipment with respect to the receiver
- Move the equipment away from the receiver
- Plug the equipment into a different outlet so that the computer and receiver are on different branch circuits

Table of Contents

Title	Page
Introduction	1
Multimeter Safety	2
Getting Started Quickly	3
How to Use the Meter.....	6
Input Terminals and Input Alert	6
Pushbuttons.....	8
Summary of Power-On Options.....	13
Digital and Analog Displays.....	13
Holster and Flex-Stand.....	17
Applications.....	17
Measuring Voltage (AC/DC)	19
Measuring Current.....	19
Continuity Testing.....	20
Measuring Resistance	20
Using Conductance for High Resistance or Leakage Tests	21

Noisy Resistance Measurements.....	22
Measuring Capacitance	22
Diode Testing.....	23
Using the Analog Display.....	24
Using the MIN MAX Recording Mode	24
Measuring Frequency	26
Measuring Duty Cycle.....	27
Pulse Width Measurements	29
Maintenance	29
General Maintenance.....	29
Calibration.....	30
Battery Replacement	30
Fuse Test 	30
Fuse Replacement 	32
Service 	32
Replaceable Parts	33
Specifications.....	36

List of Tables

Table	Title	Page
1.	International Electrical Symbols.....	3
2.	Input Terminals and Limits.....	4
3.	Beeper Response in Continuity Test	7
4.	Options Available at Power-on	14
5.	Approximate Charge Rate for Capacitors	23
6.	Frequency Counter Operation With Current Inputs	27
7.	Replaceable Parts	34

List of Figures

Figure	Title	Page
1.	Summary of Pushbutton Operation	9
2.	Holster and Flex-Stand	18
3.	Duty Cycle Measurement of Typical Logic Signal.....	28
4.	Battery and Fuse Replacement	31
5.	Replaceable Parts	35

Introduction

Note

This meter has been designed and tested according to IEC 1010-1, Safety Requirements for Electrical Equipment for Measurements, Control, and Laboratory Use. This manual contains information and warnings which must be followed to ensure safe operation and retain the meter in safe condition. If the meter is not used as described in this manual, the safety features of the meter might be impaired.



Read "Multimeter Safety" before using the meter.

The Fluke 87 True RMS Multimeter (also referred to as "the meter") is a handheld, 4000-count instrument that is designed for use in the field, laboratory, and at home. The meter combines the precision of a digital meter with the speed and versatility of a high resolution analog display. Frequencies between 0.5 Hz and 200 kHz can be measured with up to 0.01 Hz resolution. The meter is powered by a 9V battery and has a rugged case sealed against dirt, dust, and moisture. A snap-on holster, with

flexible stand (Flex-Stand™), protects the meter from rough handling. The flexible stand allows the meter to be stood or hung.

The meter also provides:

- A MIN MAX Recording mode, in which the meter "remembers" the lowest and highest readings, calculates the true average of all readings taken over a period as long as thirty-six hours, and displays these values. The beeper emits a Min Max Alert™ when a new minimum or maximum reading is recorded.
- A Peak MIN MAX mode that captures changes as short as 1 millisecond.
- An alternate Frequency Counter mode that measures duty cycle and displays it as a value between 0.1 and 99.9%.
- An Input Alert™ that causes the beeper to sound if the test leads are plugged into the wrong input terminals for the function being performed.
- A REL mode that allows you to store a reading in memory, and display the difference between the stored value and subsequent readings.

- A Touch Hold® mode that allows you to keep your eyes fixed on the probes when taking measurements in difficult or hazardous circumstances, then read the display when it is convenient and safe.
- A display back-light that makes the meter useable in dark areas.
- A 4 ½-digit display mode for a ten times increase in resolution.
- A Capacitance mode that measures capacitors from 0.01 nF to 5 µF.

After unpacking the meter, if you notice that the meter is damaged or something is missing, contact the place of purchase immediately. Save the shipping container and packing material in case you have to reship the meter.

Multimeter Safety

Before using the meter, read the following safety information carefully. In this manual the word, "**Warning**," is reserved for conditions and actions that pose hazard(s) to the user; the word, "**Caution**," is reserved for conditions and actions that may damage your meter. The symbols shown in Table 1 are used internationally to denote the electrical functions and conditions indicated. If the meter is not used as described in this manual, the safety features of the meter might be impaired.







2

- Avoid working alone.
- Do not allow the meter to be used if it is damaged, or it's safety is impaired.
- Inspect the test leads for damaged insulation or exposed metal. Check test lead continuity. Damaged leads should be replaced.
- Be sure the meter is in good operating condition. During a continuity test, a meter reading that goes from overload (OL) to 0 generally means the meter is working properly.
- Select the proper function and range for your measurement.
- In order to maintain the safety protection of this meter, use only parts listed in the Service Manual. Refer to Table 7 for the Service Manual part number.
- CAT III: For making measurements on equipment in fixed installations (industrial).

Warning

To avoid electrical shock, use caution when working above 60V dc or 30V ac rms. Such voltages pose a shock hazard.

Table 1. International Electrical Symbols

	AC-Alternating Current		See Explanation in Manual
	DC-Direct Current		Double insulation (Protection Class II)
	Either DC or AC		Fuse
	Ground		

- Disconnect the live test lead before disconnecting the common test lead.
- Follow all safety procedures for equipment being tested. Disconnect the input power and discharge all high-voltage capacitors through a protective impedance before testing in the Ω and \rightarrow functions.
- When making a current measurement, turn the power off before connecting the meter in the circuit.
- Check meter fuses before measuring current transformer secondary or motor winding current. (See "Fuse Test" in the "Maintenance" Section.) An open fuse may allow high voltage build-up, which is potentially hazardous.

Getting Started Quickly

Examine the meter carefully, familiarizing yourself with the layout of the input terminals, rotary switch, pushbuttons and display. Notice the Warning information and summary of power-on options engraved into the rear panel.

If you have used a multimeter before, simply examining your meter will probably give you a good idea how to use it. The following procedure is an overview of how to take basic measurements.

Warning

To avoid electrical shock or damage to the meter, do not apply more than 1000V between any terminal and earth ground.

1. Insert the test leads in the appropriate input terminals (see Table 2). If the test leads are in the wrong input terminals when the meter is turned on and the beeper has not been disabled, the beeper will emit a warning. See "Input Terminals and Input Alert", below.

Table 2. Input Terminals and Limits

Function	Input Terminals		MIN Display Reading †	MAX Display Reading	Maximum Input
	Red Lead	Black Lead			
\tilde{V}	$V\Omega \rightarrow \rightarrow$	COM	0.01 mV	1000V	1000V
\bar{V}	$V\Omega \rightarrow \rightarrow$	COM	0.0001V	1000V	1000V
\overline{mV}	$V\Omega \rightarrow \rightarrow$	COM	0.01 mV	400.0 mV	1000V
Ω	$V\Omega \rightarrow \rightarrow$	COM	0.01 Ω	40.00 M Ω	1000V
nS	$V\Omega \rightarrow \rightarrow$	COM	0.001 nS	40.00 nS	1000V
$\rightarrow \rightarrow$	$V\Omega \rightarrow \rightarrow$	COM	0.01 nF	5.00 μ F	1000V
$\rightarrow \rightarrow$	$V\Omega \rightarrow \rightarrow$	COM	0.0001V	3.000V	1000V
A \cong	A	COM	0.1 mA	20.00A*	11A 1000V Fast Fuse**
mA \cong μ A \cong	mA/ μ A mA/ μ A	COM COM	0.001 mA 0.01 μ A	400.0 mA 4000 μ A	44/100A 1000V Fast Fuse**
<p>* 10A continuous, 20A for 30 seconds maximum. ** Fuse protected. † See the 4½ digit display mode on page 8.</p>					

2. To turn the meter on and select a function, turn the rotary switch from OFF to the appropriate switch position. All segments on the liquid-crystal display (LCD) will turn on for one second, then the meter is ready for normal operation. If you would like to freeze the display with all segments on, press and hold down any button, while turning the meter on. As long as the button is held down, all LCD segments will remain on.
3. To select an additional operation, press the appropriate pushbuttons above the rotary switch as described in the items below. (See also, Figure 1.)
 - To operate the MIN MAX and RANGE buttons: press to select, press again to scroll or increment, and press and hold for two seconds to exit.
 - To operate the Hz button: press to select the frequency mode, press again to select duty cycle, and press again to exit.
 - To operate the back-lit display, press the YELLOW button. The back-light automatically turns off in 68 seconds to conserve battery life.

- To operate the remaining buttons: press to select and press again to exit.

Note

The response of the display and the pushbuttons slows down in the capacitance mode.

An annunciator is displayed when a mode has been selected. A quick way to reset all the pushbuttons to their default state is to turn the rotary switch to an adjacent function and then back to the function you are using.

4. To take a measurement, use the test lead probes to make the proper contacts. Remember, insert the meter in the circuit in parallel for voltage and in series for current measurements. Read the measurement on the display. If you did not manually select a range (by using the RANGE button), the range that provides the best resolution is automatically selected.
5. To run a performance check of the meter, turn the rotary switch to Ω and connect a test lead from the **V Ω →** input to the mA μ A input. (If you are using a test probe, touch the half of the input contact nearest the LCD.) The display should read 1.000 k Ω \pm 5 digits. With the rotary switch still at Ω , test the A fuse (11A) by inserting the plug end of the test lead into the A input and test the mA μ A fuse (44/100A) by

inserting the plug end of the test lead into the mA uA input. The beeper emits an Input Alert if the fuses are good.

Although this procedure will allow you to get started quickly, we suggest that you take the time to read the remainder of this manual so that you can learn to take full advantage of your meter's capabilities.

How to Use the Meter

This section describes your meter and how to use it. *For ease of reference, each description is numbered and keyed to the illustration inside the front cover.*

Input Terminals and Input Alert

Items 1-4 describe the input terminals. (See Table 1 for overload limits.) If the test leads are connected to the Amperes input terminal, and the function selector switch is not in the Amp measurement position, the beeper will emit an Input Alert. An Input Alert will also sound if the test leads are connected to the mA uA terminal and the function switch is not in either Amp position. After an Input Alert sounds, the meter will attempt to take a reading from inputs applied to the $V\Omega \rightarrow$ terminal. Input Alert can be disabled by pressing  while turning the rotary switch from OFF to any function position.

① **A Amperes Input Terminal.**

For current measurements (ac or dc) up to 10A continuous (20A for 30 seconds) when function selector switch is set to $\text{mA} \rightarrow$ or $\text{A} \sim$

② **mA μ A Milliamp/Microamp Input Terminal**

For current measurements up to 400 mA (ac or dc) when the function selector switch is set to $\text{mA} \rightarrow$ or $\mu\text{A} \approx$ $\text{A} \sim$

③ **COM Common Terminal**

Return terminal for all measurements.

④ **$V\Omega \rightarrow$ Volts, Ohms, Diode Test Input Terminal**

Function Selector Rotary Switch

- ⑤ Item 5 describes functions that are selected by setting the rotary switch. Each time the rotary switch is moved from OFF to a function setting, all LCD segments will turn on for one second as part of a selftest routine. (This selftest routine is also performed if the rotary switch is turned slowly from one position to another.) The meter is then ready for normal operations and will respond to the rotary switch and pushbuttons.

OFF

Power to the meter is turned off.

\tilde{V} Volts ac

Autoranges to the 400 mV, 4V, 40V, 400V or 1000V range.

\bar{V} Volts dc

Autoranges to the 4V, 40V, 400V or 1000V range.

\overline{mV} Millivolts dc

Single 400 mV range.

$\Omega \leftrightarrow C$ Resistance (Ω), conductance ($1/\Omega$), capacitance or continuity testing.

Press BLUE button to toggle between the resistance and capacitance function. (The response of the display and the pushbuttons slows down in the capacitance mode.)

Autoranges to the 400 Ω , 4 k Ω , 40 k Ω , 400 k Ω , 4 M Ω , or 40 M Ω resistance range.

In Manual Ranging mode, 40 nS conductance range (equal to a 25-100,000 M Ω range) is selectable. (See item 9.)

Autoranges to the 05.00 nF, .0500 μ F, 0.500 μ F, or 05.00 μ F capacitance range.

When testing continuity, the beeper sounds if the resistance falls below the typical values indicated in Table 3.

Table 3. Beeper Response in Continuity Test

Input Range	Beeper On If
400.0 Ω	< 40 Ω
4.000 k Ω	< 200 Ω
40.00 k Ω	< 2 k Ω
400.0 k Ω	< 20 k Ω
4.000 M Ω	< 200 k Ω
40.00 M Ω	< 200 k Ω

$\rightarrow|$ Diode Test

Measures forward voltage of semiconductor junction(s) at approximately 0.5 mA test current. Single 0-3V range.

mA  **Milliamps or amperes**
A 

Defaults to dc. Press BLUE button to toggle between dc and ac.

Autoranges to the 40 mA or 400 mA range when using the mA μ A input terminal, or to the 4000 mA or 10A range when using the [A] input terminal.

μ A  **Microamps**

Defaults to dc. Press BLUE button to toggle between dc and ac.

Autoranges to the 400 μ A or 4000 μ A range when using the mA μ A input terminal.

Pushbuttons

Items 6-13 describe how to use the pushbuttons. These buttons are used (in conjunction with rotary switch) to select operating modes and set power-on options. When a button is pushed the beeper sounds (unless the beeper has been turned off or the Data Output mode has been selected). A summary of pushbutton operations is shown in Figure 1. An annunciator is displayed to indicate that a mode or option has been selected. A quick way to reset all the pushbuttons to their default state is to turn the rotary switch to an adjacent function and then back to the function you are using.

8

⑥  **Display Back-Light**

Press the YELLOW button to turn on the back-light. Back-light turns off automatically after 68 seconds to extend battery life.

Power-On Option: 4½-Digit Display Mode

The meter displays the readings at 10 times the resolution with a maximum display at 19,999 counts. The display is updated once per second. The 4½-digit display mode works in all functions except capacitance, Peak MIN MAX and 100 millisecond MIN MAX. Use manual ranging for best performance.

⑦  **AC or DC, Resistance or Capacitance**

Press BLUE button to toggle between ac and dc when measuring current, or between capacitance and resistance when the rotary switch is set to .

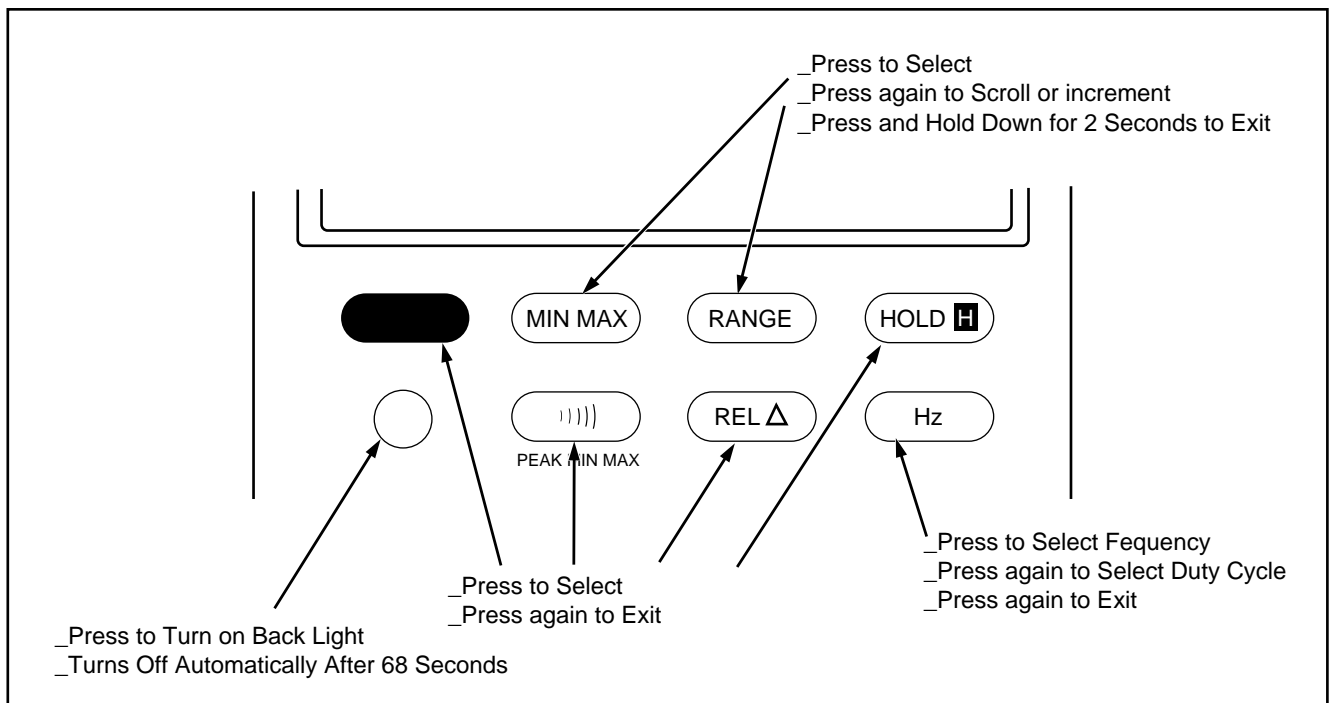

Figure 1. Summary of Pushbutton Operation

ep1f.eps

Power-On Option: Disable Automatic Power-off

Automatic Power-off extends the life of the battery by turning part of the meter off if neither the rotary switch nor a pushbutton is operated for half an hour. (Automatic Power-off is not allowed in the MIN MAX Recording or Data Output modes.) The meter turns back on if either the rotary switch is turned or a pushbutton is pressed.

8 **MIN MAX** Minimum (MIN), Maximum (MAX), Average (AVG) Recording

Press **MIN MAX** to enter the MIN MAX Recording mode (manual range only). Select the proper range before selecting MIN MAX to ensure that the MIN MAX reading will not exceed the measurement range. The minimum, maximum, and average values are then reset to the present input; the RECORD annunciator turns on; the AUTO annunciator turns off; and the automatic power-off feature is disabled.

In the MIN MAX Recording mode, the minimum and maximum readings are stored in memory. The beeper emits a tone when a new minimum or maximum value is recorded. A continuous beeper tone is emitted when an overload is recorded. Push **MIN MAX** to cycle

through the maximum (MAX), minimum (MIN), average (AVG), and present readings. The MIN, MAX, or AVG annunciator turns on to indicate what value is being displayed. If an overload is recorded, the averaging function is stopped and the average value becomes OL (overload).

The true average of all the readings taken over at least a thirty-six hour period can be displayed. If this duration is exceeded, the actual minimum and maximum readings will continue to be captured and can be displayed. However, new averages are no longer calculated. The last average calculated is retained as the average reading.

At normal (default) record speed, changes to the voltage, current, or resistance inputs that last at least 100 milliseconds are recorded, and the "100 ms" annunciator turns on. Press and hold down the **MIN MAX** for 2 seconds to exit and erase recorded readings.

In the MIN MAX mode, press **|||||** to select the Peak MIN MAX mode ("1 ms", "RECORD", and "MAX" are displayed). Voltage or current inputs that last for 1 milliseconds or longer are captured. Press **MIN MAX** to select the minimum (MIN) reading. Press

again to return to the maximum (MAX) reading. To reset the Peak MIN MAX mode press **(HOLD)** twice: the first press exits the mode, and the second press re-enters the mode. To completely exit the MIN MAX mode, press **(MIN MAX)** for one second. In Peak MIN MAX mode, the present reading, average (AVG) readings, and analog display are not displayed. Before selecting Peak MIN MAX, select DC voltage or current to DC couple the input waveform; or AC voltage to capacitively couple the input waveform. Peak MIN MAX works in all functions except ohms, frequency and capacitance.

In the MIN MAX Recording mode, press **(HOLD)** to stop the recording of readings; press again to restart recording. If recording is stopped, the minimum, maximum, average, and present values are frozen, but the analog display continues to be active. When recording is stopped, the stored readings are not erased and you can still scroll through these readings.

Power-On Option: Select High Accuracy MIN MAX Recording

The High Accuracy MIN MAX Recording mode has a response time of approximately 1 second. Changes of

more than 1 second duration are recorded. The "1 s" annunciator is turned on. In the Frequency Counter mode, readings are always recorded at the high accuracy recording speed; the response time is not selectable.

9 **(RANGE) Manual Ranging**

Press **(RANGE)** to select the Manual Range mode and turn off the AUTO annunciator. (The meter remains in the range it was in when manual ranging was selected.)

In the Manual Range mode, each time you press **(RANGE)** button, the range (and the input range annunciator) increments, and a new value is displayed. If you are already in the highest range, the meter "wraps around" to the lowest range. (In the Frequency Counter mode, pressing **(RANGE)** manually selects the input voltage or current range.) To exit the Manual Range mode and return to autoranging, Press and hold down **(RANGE)** for 2 seconds. The AUTO annunciator turns back on.

When the range is changed manually, the Touch Hold, MIN MAX Recording, and REL[ative] modes are disabled.

Power-On Option: Rotary Switch Test



The Rotary Switch Test is used only for servicing purposes. See the 80 Series Service Manual for details. In the Rotary Switch Test mode, normal meter functions are disabled. To exit the Rotary Switch mode, turn the rotary switch to OFF and back to any switch setting.



10 Display Hold

Warning

Touch hold will not capture unstable or noisy readings. Do not use touch hold to determine that circuits with dangerous voltage are dead.

Press  to toggle in and out of the Touch Hold mode, except if you are already in the MIN MAX Recording or Frequency Counter mode.

In the Touch Hold mode, the  annunciator is displayed and the last reading is held on the display. When a new, stable reading is detected, the beeper emits a tone, and the display is automatically updated. Pressing  when you are in the Touch Hold mode causes you to exit Touch Hold and enter the MIN MAX Recording mode.

In the MIN MAX Recording mode, press  to stop the recording of readings; press  again to resume recording. (Previously recorded readings are not erased.)

In the Frequency Counter mode (Hz), press  to stop the display; press  again to start it.

11 Continuity Beeper/Peak MIN MAX

Press  to toggle the beeper on or off for continuity testing in the ohms function.

The beeper responds as indicated in Table 2.

In the Frequency Counter mode, press  to change the trigger slope from positive-going edges to negative-going edges. The slope selected is indicated by the analog display polarity annunciator (\pm).

In the MIN MAX mode, press  to toggle in and out of the Peak MIN MAX mode. See item 8.

Power-On Option: Disable Beeper

When the beeper has been disabled, all beeper functions are turned off. The beeper is automatically disabled if the meter is in the Data Output mode.

12 **REL Δ** Relative Readings

Press **REL Δ** to enter the Relative mode, zero the display, and store the displayed reading as a reference value. The relative mode annunciator (Δ) is displayed. Press **REL Δ** again to exit the relative mode.

In the Relative mode, the value shown on the LCD is always the difference between the stored reference value and the present reading. For example, if the reference value is 15.00V and the present reading is 14.10V, the display will indicate -0.90V. If the new reading is the same as the reference value, the display will be zero.

13 **Hz** Frequency Counter Mode and Duty Cycle

Press the **Hz** to select the Frequency Counter mode; press again to select duty cycle (the alternate counter function); press again to exit. The analog display does not operate in either the Frequency Counter mode or duty cycle.

In Frequency Counter mode, the Hz annunciator is displayed. The frequency function autoranges over

five ranges: 199.99 Hz, 1999.9 Hz, 19.999 kHz, 199.99 kHz, and greater than 200 kHz. The RANGE button manually selects the voltage or current input range. If duty cycle is selected, readings from 0.1 through 99.9 are displayed. The "Hz" annunciator turns off and "%" turns on.

Power-On Option: High Input Impedance Mode

The input impedance of the \overline{mV} function (400 mV range) is changed from 10 megohms to greater than 4000 megohms.

Summary of Power-On Options

You can select a number of options each time you turn the meter on. These power-on options (also listed on the rear of the meter) are selected by holding down one or more of the pushbuttons for approximately 2 seconds while turning the function switch to any ON position. All power-on options are only disabled when the rotary switch is turned to OFF. Each power-on option is discussed in detail under "Pushbuttons" and summarized in Table 4.

Digital and Analog Displays

Items 14-19 describe the digital and analog displays and LCD annunciators.

Table 4. Options Available at Power-on

Option	Pushbutton	Function
Automatic Power-off	Blue	Disable Automatic Power-off
4½ Digit Mode	Yellow	Select 4½ digit display. Full scale 19,999 counts.
MIN MAX Record Speed	MIN MAX	Select High Accuracy record speed. (Response time approximately 1 second)
Rotary Switch Test	Range	For servicing purposes only. See 80 Series Service Manual
Data Output	Hold H	Enable ultrasonic data transmission. (For use in factory testing only, cannot be modified for customer use. Beeper functions disabled.)
Disable Beeper	⌋⌋⌋	Turns off all beeper functions
High Input Impedance in mV DC	Hz	Provides >4000 MΩ input impedance for 400 mV dc range

⑭ **Digital Display**

Digital readings are displayed on a 4000-count display with polarity (\pm) indication and automatic decimal point placement. When the meter is turned on, all display segments and annunciators appear briefly during a selftest. The display updates four times per second, except when frequency readings are taken. Then the update rate is 3 per second.

⑮  **Analog Display**

The analog display is a 32-segment pointer that updates at a 40 times per second rate and is the best display to use for readings that are changing. It does not operate in the Capacitance or Frequency Counter functions or in the Peak MIN MAX mode.

For increased sensitivity, the analog pointer moves across the scale four times for each range. The pointer returns to 0 (wraps around) when the equivalent digital display reaches 1024, 2048, and 3072 counts. Select the next higher range if the pointer is too sensitive.

The analog pointer indicates a value lower than the digital display (up to 2.5% of range). Examples on the 40V range are:

Digital Display =	5.00V	15.00V	25.00V	35.00V
Analog Pointer=	4.8	4.5	4.5	4.2
Wrap	= First	Second	Third	Fourth
Indication	= 4.8V	14.5V	24.5V	34.2V

With stable inputs, use the digital display for the best sensitivity and precision.

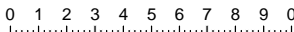
①⑥  **Analog Display Scale**

Scale for each 1000 counts in the digital display.

①⑦ **± Analog Display Polarity**

Indicates the polarity of the input except in the Frequency Counter mode, when it indicates the polarity of the trigger slope (edge).

①⑧ **4000 Input Range Annunciator mV**

Displays 4, 40, 400, or 4,000 input range for volts, amps, or ohms, and 400 mV.

①⑨ **OL Overload Indication**

Displayed on digital display when input (or math calculation in REL mode) is too large to display. If you are taking duty cycle readings, OL is displayed if the input signal stays high or low. All segments are illuminated on analog display.

Items 20-23 describe annunciators that indicate the mode or state in which the meter is operating:

②⑩ **AUTO Autorange**

Meter is in the autorange mode and will automatically select the range with the best resolution. Meter powers-on in autorange mode.

In the autorange mode, the meter ranges up at 4096 counts and ranges down at 360. When the meter is in the Manual Range mode, the overrange arrow is displayed until you manually select a range appropriate for the input value.

See item 9 for manual ranging.



21 **Low Battery**

Meter is powered by a single 9V battery, with a typical life of 400 hours with an alkaline battery. At least 8 hours of battery life remain when is first displayed. A battery check is taken between measurements.



22 **Negative Polarity**

Automatically indicates negative inputs. When REL is enabled, indicates negative results of math calculations.



23 **Beeper**

Continuity test is enabled. See item 11 and Table 2.

Items 24 through 31 describe math function annunciators and the annunciators that indicate the units of the value displayed.



24 **Relative Mode**

The value displayed is the difference between the present measurement and the previously stored reading. See item 12.



25 **100 ms Normal Recording Speed in MIN MAX Recording Mode**

Input changes of 100 milliseconds or longer will be recorded. In the 1 s High Accuracy MIN MAX Recording Mode, the recording speed is 1 second.

1 ms **Peak MIN MAX Recording Mode**

Input changes of 1 millisecond or longer will be recorded.



26 **RECORD Minimum, Maximum, and Average Recording**

Readings are being recorded in the MIN MAX Recording mode. A maximum (MAX), minimum (MIN), or average (AVG) reading can be displayed.



27 **MAX Maximum Value in MIN MAX Recording Mode**

The value displayed is the maximum reading taken since the MIN MAX Recording mode was entered.

②⑧ **MIN** **Minimum Value in MIN MAX Recording Mode**

The value displayed is the minimum reading taken since the MIN MAX Recording mode was entered.

②⑨ **AVG** **Average Value in MIN MAX Recording Mode**

The value displayed is the true average of all readings taken since the MIN MAX Recording mode was entered.

③⑩  **Hold**

The meter is operating in a Display Hold mode. See item 10 for Display Holds.

③① The following annunciators indicate the unit of the value displayed:

AC	Alternating current or voltage
DC	Direct current or voltage
V	Volts
mV	Millivolts (1×10^{-3} volts)
A	Ampere (amps). Current
mA	Milliampere (1×10^{-3} amps)
uA	Microampere (1×10^{-6} amps)

nS Nanosiemens (1×10^{-9} siemens). Conductance ($1/\Omega$)

% Percent Annunciator (for duty cycle readings only)

Ω Ohms. Resistance

k Ω Kilohm (1×10^3 ohms). Resistance

M Ω Megohm (1×10^6 ohms). Resistance

Hz Hertz (1 cycle/sec). Frequency

kHz Kilohertz (1×10^3 cycles/sec). Frequency

μ F Microfarads (1×10^{-6} Farads). Capacitance

nF Nanofarads (1×10^{-9} Farads). Capacitance

③②  Not Used

Duty Not Used

Holster and Flex-Stand

The meter comes with a snap-on holster that absorbs shocks and protects the meter from rough handling. The holster is equipped with a Flex-Stand. Some uses of the holster with Flex-Stand are shown in Figure 2.

Applications

This section discusses some common applications for your meter, and alerts you to some considerations to keep in mind when taking measurements.

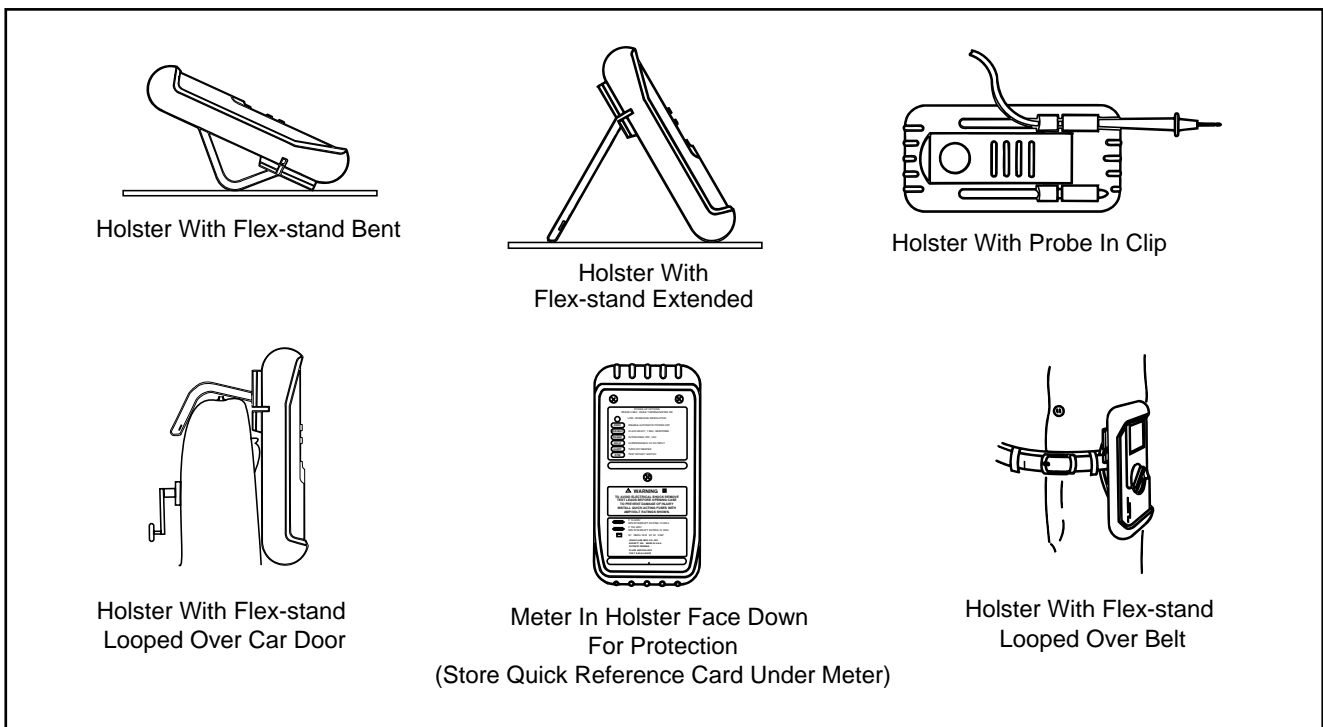

Figure 2. Holster and Flex-Stand

ep2f.eps

Measuring Voltage (AC/DC)

To measure voltage, connect the meter in parallel with the load or circuit under test. Each of the five ac/dc voltage ranges presents an input impedance of approximately 10 M Ω in parallel with less than 100 pF. Ac voltage is ac-coupled to the 10 M Ω input.

To improve the accuracy of dc voltage measurements made in the presence of ac voltages, measure the ac voltage first. Note the ac voltage range and manually select a dc voltage range that is the same or higher than the ac voltage range. This method improves the dc voltage accuracy by ensuring that the input protection circuits are not being activated. A typical application is measuring the dc offset voltage of an amplifier in the presence of an ac signal.

Measurement errors due to circuit loading can result when making either ac or dc voltage measurements on circuits with high source impedance. In most cases, the error is negligible (0.1% or less) if the measurement circuit source impedance is 10 kilohms or less.

Measuring Current



Do not attempt an in-circuit current measurement where the potential to earth is greater than 1000V. You may damage the meter or be injured if the fuse blows while current is being measured in a circuit which exhibits an open circuit voltage greater than 1000V.

To measure current, connect the meter in series with the load or circuit under test. Press the BLUE button to toggle between alternating and direct current.



If you do not know approximately what the current is, connect the circuit to the A input terminal first to see if you have a safe level for the mA μ A input terminal. Use the mA μ A input terminal for current up to 400 mA.

When measuring current, the meter's internal shunt resistors develop a voltage across the meter's terminals called "burden voltage." This voltage drop is very low in your meter, but it may affect precision circuits or measurements.

To calculate the burden voltage: in A, multiply the display reading by 0.03V; in mA, multiply the display reading by 1.8 mV; in μ A, multiply the display reading by 100 μ V. For example, at a 20 mA display reading, the burden voltage is $20.00 \times 1.8 \text{ mV} = 36 \text{ mV}$.

The approximate resistance between the input terminals is 0.03 ohms for A, 1.8 ohms for mA, and 100 ohms for μ A.

Continuity Testing

Continuity testing verifies that circuit connections are intact. To perform audible continuity tests, set the rotary switch to  press  and connect the meter to your circuit. Test resistances below the values listed in Table 3 cause the meter to emit a continuous tone. Use the 400 ohm range for most wiring checks.

The continuity mode is extremely fast and can be used to detect either shorts or opens that last for as little as 1 millisecond. When a change is detected, the beeper tone is "stretched" to last at least 1/4 second so you can hear it and detect both shorts and opens. This can be a valuable troubleshooting aid when looking for intermittents associated with cables, connections, switches, relays, etc. If the test value is very close to the threshold, erratic beeps can also occur due to environmental electrical noise (EMI).

20

Measuring Resistance

Caution

Turn off power on the test circuit and discharge all capacitors before attempting in-circuit resistance measurements. If an external voltage is present across a component, it will be impossible to take an accurate measurement of the resistance of that component.

The meter measures resistance by passing the same current through a precision reference resistor and the external circuit or component, then ratios and measures the voltage drop across each ($\Omega = V_{\text{unknown}} / V_{\text{reference}}$). Remember, the resistance displayed by the meter is the total resistance through all possible paths between the probes. This explains why in-circuit measurement of resistors does not often yield the ohms value indicated by the resistor's color code.

The resistance in the test leads can diminish accuracy on the lowest (400-ohm) range. The error is usually 0.1 to 0.2 ohms for a standard pair of test leads. To determine the error, short the test leads together and read the resistance of the leads. Use the Relative (REL) mode to automatically subtract the lead resistance from resistance measurements.

When measuring resistance, be sure that the contact between the probes and the circuit under test is good. Dirt, oil, solder flux, or other foreign matter seriously affects resistance.

Most in-circuit resistance measurements can be made without removing diodes and transistors from the circuit. The full-scale measurement voltage produced on ranges below 40 M Ω does not forward-bias silicon diodes or transistor junctions enough to cause them to conduct. Use the highest range you can (except 40 M Ω) to minimize the possibility of turning on diodes or transistor junctions. Full-scale measurement voltage in the 40-M Ω range does forward-bias a diode or transistor enough to cause it to conduct.

In resistance (and all other functions except current), the mA μ A input is connected to a 1-k Ω resistor. If the mA μ A input protection fuse is good, this input can be used as a partial check of proper operation in resistance. The input receptacles have split contacts; touch the probe to the half nearest the LCD. The 1-k Ω resistor is protected by a 3-diode clamp. Do not apply external voltage; it may blow the fuse.

Using Conductance for High Resistance or Leakage Tests

Conductance is the inverse of resistance (i.e., 1/ohms) and is measured in units of nanosiemens (nS = 1×10^{-9} Siemens). The 40-nS range on your meter effectively extends the resistance measurement capability to 100,000 M Ω . The 40-nS range can, therefore, be used to test the resistance or leakage in insulators, diodes, transistors, cables, connectors, printed circuit boards, transformers, motors, capacitors, or other high resistance components.

To measure conductance, set the rotary switch to Ω and press **RANGE** to manually increment to the 40-nS range. Plug the test leads into the V Ω and COM input terminals, and then connect these leads across the unit under test. The reading displayed is in units of conductance (nS). To convert this reading to megohms, divide the reading into 1000 (1000/displayed reading in nS = M Ω). For example 2.00 nS converts to 500 M Ω (1000/2.00). High value resistance measurements are susceptible to induced noise and may require careful shielding. To smooth out most noisy readings, enter the MIN MAX Recording mode and scroll to the average (AVG) reading.

Note

In the conductance range, there is normally a small residual reading with open test leads. To ensure accurate measurements, connect clean test leads to the meter and (with the leads open) read the residual leakage in nanosiemens. Correct subsequent measurements by using the Relative mode (REL) to zero the display, which subtracts the residual from the readings.

Diode leakage tests require that the diode junction be reverse-biased when being measured. To do this, connect the anode of the diode to the COM input terminal and the cathode (ring) of the diode to the $V\Omega \rightarrow +$ input terminal. Leakage at the test voltage being applied can then be read in terms of conductance.

High-voltage, stacked diode, assemblies can usually be tested for forward and reverse resistance changes using conductance. These assemblies typically have such high forward voltage drops that the diode test or resistance modes cannot test them.

Noisy Resistance Measurements

Your Fluke meter is designed to tolerate up to several volts of ac noise. Noise appears as changing numbers on the digital display and as an oscillating analog display.

Changing the range may reduce the noise. To smooth out the effect of noise on your readings, enter the MIN MAX Recording mode and scroll to the average reading.

Measuring Capacitance**Caution**

Turn off power and discharge the capacitor before attempting a capacitance measurement. Use the \bar{V} function to confirm that the capacitor is discharged.

The meter measures capacitance by charging the capacitor with a known current, measuring the resultant voltage, and calculating the capacitance. The measurement takes about 1 second per range (push button responses also take about 1 second). The capacitor charge can be up to 1.2V.

For measuring capacitor values up to 5.0 μF , turn the rotary switch to $\Omega \rightarrow +$, press the BLUE button, and connect the test leads to the capacitor. The meter will select the proper range automatically. Each measurement takes about 1 second per range. When making repeated measurements of similar values, press **RANGE** to manually select the proper range and to speed up subsequent measurements. For capacitors less than 5 nF or in noisy

environments, use short test leads or a test fixture (1 nF = 1000 pF).

The measurement accuracy of capacitors less than 5 nF can be improved by first using the Relative mode to zero the display and automatically subtract the residual meter and test lead capacitance. Since the Relative mode also selects manual ranging, zero the residual capacitance only when measuring small value capacitors.

Residual voltage charges on the capacitor, or capacitors with poor insulation resistance or poor dielectric absorption may cause measurement errors.

To check capacitors larger than 5 μF , select Ω with the rotary switch (or press the BLUE button if you are in the capacitance mode). Select an appropriate range from Table 5. Discharge the capacitor, connect the capacitor to the meter, and time the number of seconds it takes for the charge to go from zero to full scale. At full scale, all of the analog display segments are on. To estimate the value of the capacitor, multiply the number of seconds times the charge rate ($\mu\text{F}/\text{sec}$) in Table 5. For example, a 10 μF capacitor takes about 34 seconds to charge in the 4 M Ω range or 3.4 seconds in the 400 k Ω range. To reconfirm your estimate, reverse the test leads; when the capacitor discharges to zero (the analog display polarity switches from - to +), start timing the recharge to full scale.

Diode Testing

To perform a diode or transistor junction test: plug the test leads into the $V\Omega\rightarrow+$ and COM inputs, turn the rotary switch to $\rightarrow+$ and connect the test leads across the diode(s).

In diode test, voltage is developed across the component(s) by a test current (approximately 0.6 mA with the test leads shorted) from the meter. Voltage is read on a single 0 to +3.000V range that can measure up to five silicon diode or transistor junctions in series. For a silicon diode, the typical forward voltage should be about 0.6V. Voltages greater than 3.00V or open test leads produce an overload (OL) reading. If the digital reading is the same in both directions, the diode junction is probably shorted. If the display reads OL in both directions, the diode junction is probably open. To protect sensitive devices, the open test lead voltage from the meter will not exceed 3.9V. Negative inputs (from an external power source, for example) are not suppressed.

Table 5. Approximate Charge Rate for Capacitors

Range	400 Ω	4 k Ω	40 k Ω	400 k Ω	4 M Ω
$\mu\text{F}/\text{sec}$	2600	275	29	2.9	0.29

Use the Touch Hold mode (see item 10) to make audible diode tests. When the test leads are placed across the diode, a good diode or transistor junction will cause the meter to beep (and update the display) in the forward-biased direction and remain silent in the reverse-biased direction. A short or resistance below about 30 k Ω will cause a beep in both directions. If an open is detected, the meter will remain silent in both directions.

Using the Analog Display

The analog display is easy to use and interpret. It functions much the same as the needle on an analog meter without the mechanical overshoot inherent in needle movements.

The analog display is especially useful for peaking and nulling, and observing rapidly changing inputs. The analog display response time is fast, and it can be used to make approximate adjustments quickly. The 4000-count digital display can then be used for final adjustment.

The analog display can also be used for limited diagnostic purposes. In situations where rapidly fluctuating signal levels make the digital display useless, the analog display is ideal. Like the needle on a Volt-ohm-milliammeter (VOM), the analog display excels at displaying trends, or slowly changing signals. Many diagnostic routines using

the analog display require practice. You will usually be looking for good or bad signal patterns that occur over some span of time. Noisy resistance measurements, for instance, create such patterns. Therefore, familiarity with analog display response and movement is necessary to accurately interpret a signal pattern. Compare the analog display response when making measurements on a unit known to be good, to the analog display response when making measurements on a faulty unit.

Using the MIN MAX Recording Mode

The MIN MAX Recording mode can be used to catch intermittents and turn on or turn off surges, verify performance, measure while you are away ("baby sit"), or take readings while you are operating the equipment under test and cannot watch the meter. The audible Min Max Alert indicates when a new minimum or maximum value has been recorded.

You can select either a 100 millisecond, 1 millisecond (Peak), or 1 second (high accuracy) "response time" for recording minimum and maximum readings. The response time is the length of time an input must stay at a new value to record the full change.

The 100 millisecond response time is best for recording power supply surges, inrush currents, and finding

intermittent failures. This mode follows the update time of the analog display. (The minimum and maximum excursions of the analog display get recorded.)

The 1 millisecond Peak MIN MAX mode is ideal for recording transients, especially from intermittent power lines or connections. This mode can also be used to measure the + and - peak values of sinewaves up to about 450 Hz, for easy measurement of both peak line voltage and line current measurements of power supplies and electrical equipment.

The high accuracy mode (1 second response time) follows the digital display and can be selected as a power-on option by pressing (MIN MAX) while turning the meter on. This mode has the full accuracy of the meter and is best for recording power supply drift, line (mains) voltage changes, or circuit performance while line voltage, temperature, load, or some other parameter is being changed.

Frequency Counter readings are recorded only in the high accuracy mode

In the MIN MAX Recording mode, the true average of all readings taken since entering MIN MAX is calculated. The average value displayed in both the 100 millisecond and 1 second modes is the mathematical integral of the input (within the response time and accuracy specifications of

the meter). When you display the average, the reading rate slows somewhat in order to calculate the average of the accumulated readings.

The average reading is useful for smoothing out unstable or changing inputs, calculating power consumption (such as kilowatt hours), estimating the percent of time a circuit is operational, or verifying circuit performance (or temperature with the optional 80TK Thermocouple Module).

If you want to record readings only during the duration of a particular test (such as during the frequency response sweep of an audio amplifier, for example), apply the input signal, start the test (or sweep, in this example), and let the meter stabilize. Now press (MIN MAX), then press (HOLD) and stop the test. The minimum, maximum, and average of all readings taken during the test are now held in memory. Momentarily press (MIN MAX) to scroll to the reading of interest. Be careful: if you hold down the (MIN MAX) for longer than a second, you will exit the MIN MAX Recording mode and erase the memory. As long as the rotary switch is not turned and the other pushbuttons (except REL) are not pressed, these readings will remain in memory until the battery dies.

Measuring Frequency

In the Frequency Counter mode, the frequency display autoranges to one of five ranges: 199.99 Hz, 1999.9 Hz, 19.999 kHz, 199.99 kHz, and greater than 200 kHz. For frequencies below 10 Hz, the update rate slows and follows the input signal. For frequencies between 0.5 Hz and 0.3 Hz, the display may not be stable. For frequencies below 0.3 Hz, the display shows 00.00 Hz.

For most frequency measurements, turn the rotary switch to \tilde{V} , connect the meter to the signal being measured, and then press Hz . Connecting the meter to the signal before pressing Hz will normally allow the meter to autorange to an appropriate range, but the minimum input signal required to trigger the frequency counter varies, depending on the range and frequency (see Specifications). If the input signal is below the trigger level, frequency measurements will not be taken. If your readings are unstable, the input signal may be near the trigger level for that range. You can usually correct this by selecting a lower range. In the Frequency Counter mode, the range (displayed in the lower-right corner of the LCD) will only change when you press the RANGE button.

If your readings seem to be a multiple of what you expected, your input signal may have distortion or ringing.

(For example, electronic motor controls distort both voltage and current waveforms.) Select a higher input range if you suspect multiple triggering. An alternative is to turn the rotary switch to \bar{V} or \bar{mV} , which will shift the trigger level from 0V to a positive voltage that changes with each range. In general, the lowest frequency displayed is the correct one.

In the Frequency Counter mode, the input range acts like an attenuator, the \tilde{V} function ac-couples the input signal, and the \bar{V} and \bar{mV} functions dc-couple the input signal. The \bar{V} function is optimized for triggering on logic and switching signals. The 4V dc range is optimized to trigger on all common 5V logic families (triggers at $1.7V \pm 0.1V$). High frequency logic signals may require the use of the 400 mV ac range. The 40V dc range is optimized to trigger on automotive switching signals (triggers at $4V \pm 1V$). All ranges in the \bar{V} function trigger at approximately 10% of range, except for the 4V range.

Frequency measurements can be made on current inputs. The inputs are always dc-coupled. The triggering characteristics are shown in Table 6.

Table 6. Frequency Counter Operation With Current Inputs

Input Range	Approximate Sensitivity (0.5 Hz - 20 kHz)	Approximate Trigger Level	
		AC Current	DC Current
μA	300 μA	0 μA	400 μA
mA	30 mA	0 mA	40 mA
A	3A	0A	4A

Measuring Duty Cycle

Duty Cycle (or duty factor) is an alternate Frequency Counter mode that displays, in percent, the time the input signal is above the trigger level (or below the trigger level if the negative trigger slope is selected). The Duty Cycle mode is optimized for measuring the on or off time of logic or switching controls. Many industrial control systems (electronic fuel injection in automobiles, for example) are pulse-width modulated, and duty cycle measurements provide a quick check on their performance.

For logic level signals, use the 4V dc range. For 12V switching signals in automobiles, use the 40V dc range.

For sine waves, use the most sensitive range you can without getting double triggering. (Normally, a clean signal can be up to ten times the amplitude of the range you are on.) Duty cycle measurements can also be used as an indication of potential triggering problems on sine wave or near sine wave signals. If you do not measure approximately 50% duty cycle, you may have a distorted waveform.

In Duty Cycle (and Frequency Counter) mode, the slope (or edge) on which the counter triggers is selected by pressing . The slope selected is indicated by a + or - annunciator in the lower-left corner of the LCD. The waveform shown in Figure 3 represents the duty cycle measurement of a typical logic signal.

The manner in which your meter takes duty cycle measurements allows it to be very tolerant of aperiodic (repetitive but not periodic) signals. Duty cycle measurements on low frequency (<400 kHz) aperiodic logic signals, especially serial communication signals, is a simple form of signature analysis. A known pattern will read the same duty cycle every time (if the pattern repeats in less than 1/3 second).

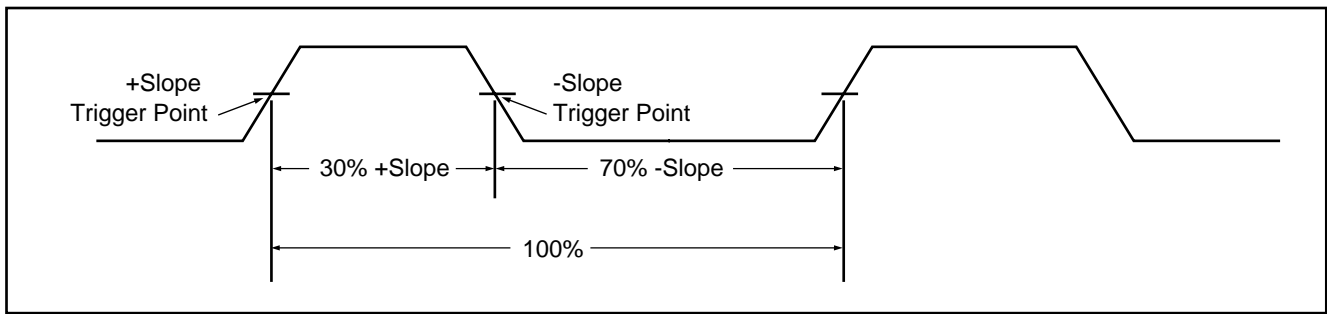

Figure 3. Duty Cycle Measurement of Typical Logic Signal

ep3f.eps

The precision and resolution of the duty cycle measurements are achieved by averaging many repetitions of the input signal. In rare cases, this averaging technique (which is similar to pulse-width averaging in a conventional counter) may cause a measurement problem called "aliasing." Aliasing results when the frequency of the input signal happens to be exactly synchronized with the reference crystal oscillator of the meter. This occurs when the frequency of the input signal can be exactly divided into the frequency of the oscillator (131,072 Hz) or one of the oscillator's harmonics. When they are nearly synchronized, the meter is "blind" to the correct duty cycle, and the display

will alternate between incorrect readings. If this occurs, and the frequency reading was stable, press **(MIN MAX)** to select the MIN MAX Record mode and scroll to the average display. The average display will stabilize on the correct duty cycle.

A common duty cycle measurement is the "dwell" angle in an automobile. Dwell is the number of degrees of distributor rotation that the points remain closed (or current is flowing in the coil). Use the following to convert a dwell angle to duty cycle (in percent):

$$\% \text{ Duty Cycle} = \frac{\text{Dwell (degrees)} \times \text{No. of Cylinders} \times 100}{360 \text{ degrees}}$$

To make a dwell measurement, set the rotary switch to \bar{v} , select the 40V range, press Hz twice (the % annunciator on the right side of the LCD should turn on), and press the ||| (to select the negative trigger slope so the measurement will be the "off" or points closed time). Then connect the COM input to ground, and connect the $V\Omega \rightarrow +$ input to the low (or switched) side of the coil. Most automobiles have the points closed for a duty cycle between 50-70%.

Pulse Width Measurements

For a periodic waveform (that is, repetitive at equal time intervals), a duty cycle measurement can be easily converted to pulse width. First measure the frequency and then measure the duty cycle. Toggle ||| to select the polarity of the pulse you want to measure. To convert frequency and duty cycle measurements into a pulse width, use the following:

$$\text{Pulse Width} = \frac{\% \text{ Duty Cycle} / 100}{\text{Frequency}}$$

Maintenance

Repairs or servicing not covered in this manual should only be performed by qualified personnel as described in the 80 Series Service Manual (refer to Table 7 for part number).

General Maintenance

Periodically wipe the case with a damp cloth and detergent (do not use abrasives or solvents). If the input alert is falsely activated by moisture:

1. Turn the multimeter off and remove all test leads.
2. Shake out the input receptacles.
3. Use a clean swab in each of the four terminals to dislodge and clean out the contamination.
4. Soak a new swab with the cleaning and oiling agent WD40. Work this swab around in the A and mA μA terminals. Since the oiling agent insulates the terminals from moisture-related shorting, this preventive treatment ensures against future erroneous Input Alerts.

Calibration

Calibrate your meter once a year to ensure that it performs according to its specifications. Contact the nearest Service Center or refer to the 80 Series Service Manual for calibration procedures. For replacement parts, see the parts list at the end of this manual.

Warning

To avoid electrical shock, remove the test leads and any input signals before replacing the battery or fuses. To prevent damage or injury, install only quick acting fuses with the amp/volt ratings shown in Figure 4.

Battery Replacement

The meter is powered by a single 9V battery (NEDA 1604, 6F22, or 006P). Referring to Figure 4, use the following procedure to replace the battery:

1. Disconnect test leads from any live source, turn the rotary switch to OFF, and remove the test leads from the front terminals.
2. The case bottom is secured to the case top by three screws and two internal snaps (at the LCD end).

Using a Phillips-head screwdriver, remove the three screws from the case bottom and turn the case over.

3. Lift the input terminal end of the case top until it gently unsnaps from the case bottom at the end nearest the LCD.
4. Lift the battery from the case bottom, and carefully disconnect the battery connector leads.
5. Snap the battery connector leads to the terminals of a new battery and reinsert the battery into the case bottom. Dress the battery leads so that they will not be pinched between the case bottom and case top.
6. Ensure that the case top rotary switch and circuit board switch are in the OFF position.
7. Replace the case top, ensuring that the gasket is properly seated and the two snaps on the case top (at the end near the LCD) are engaged. Reinstall the three screws.

Fuse Test

Use the following procedure to test the internal fuses of the meter.

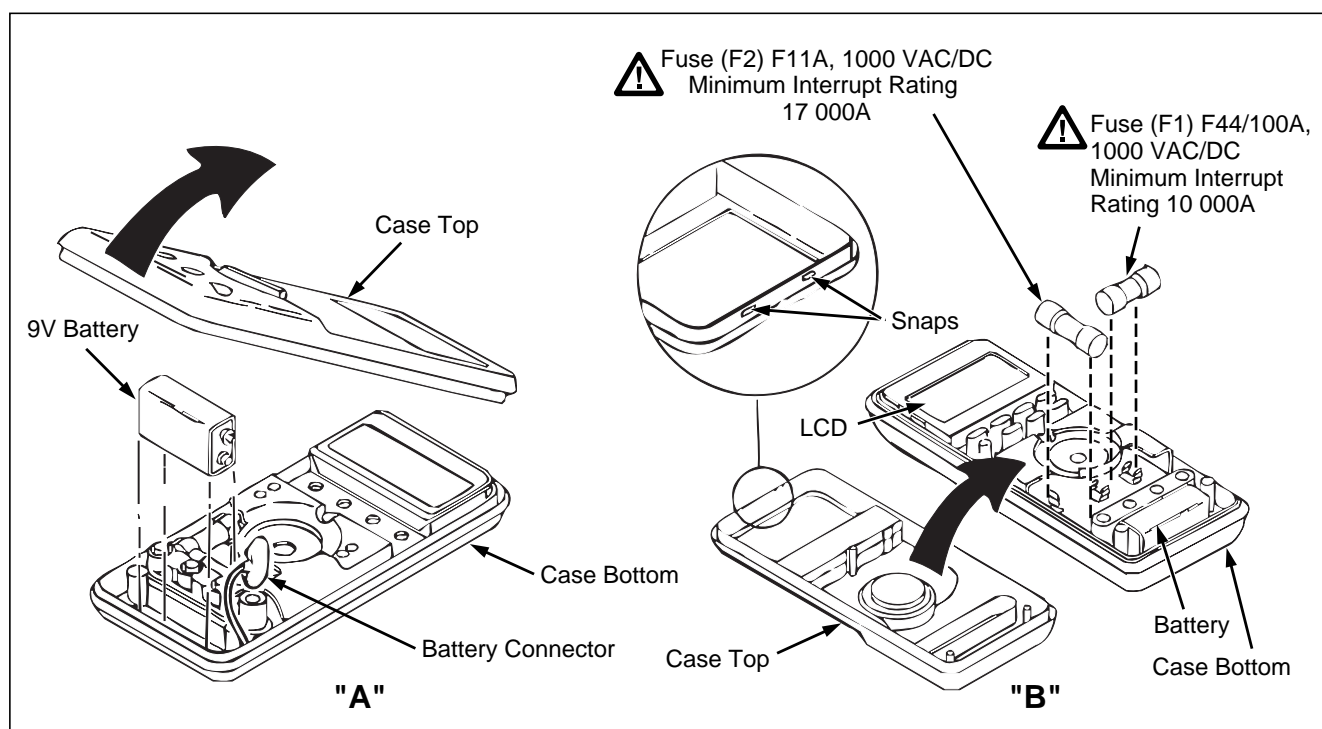

ep4f.eps

Figure 4. Battery and Fuse Replacement

1. Turn the rotary selector switch to Ω .
2. Plug a test lead into the $V\Omega$ input terminal and touch the probe to the [A] input terminal. Because the receptacles of the input terminals contain split contacts, be sure that you touch the probe to the half of the receptacle contact that is nearest the LCD.
3. The display should indicate between 00.0 and 00.5 ohms. This tests F2 (11A, 1000V). If the display reads OL (overload), replace the fuse and test again. If the display reads any other value, have the meter serviced.
4. Move the probe from the A input terminal to the mA μ A input terminal.
5. The display should indicate between 0.995 k Ω and 1.005 k Ω . This tests F1 (44/100A, 1000V). If the display reads OL (overload), replace the fuse and test again. If the display reads any other value, have the meter serviced.

Fuse Replacement

Referring to Figure 4, use the following procedure to examine or replace the meter's fuses:

1. Perform steps 1 through 3 of the battery replacement procedure.
2. Remove the defective fuse by gently prying one end of the fuse loose and sliding the fuse out of the fuse bracket.
3. Install a new fuse of the same size and rating. Make sure the new fuse is centered in the fuse holder.
4. Ensure that the case top rotary switch and circuit board switch are in the OFF position.
5. Replace the case top, ensuring that the gasket is properly seated, the battery leads are properly dressed, and the two snaps on the case top (at the end near the LCD) are engaged. Reinstall the three screws.

Service

If the meter fails, check the battery and fuse(s) and replace as needed. If the meter still does not work properly, review this manual to make sure you are operating it correctly. If the meter still malfunctions, pack it securely in its original shipping container and forward it, postage paid, to the nearest Service Center. Include a description of the malfunction. Fluke assumes NO responsibility for damage in transit.

A meter under warranty will be promptly repaired or replaced (at Fluke's option) and returned at no charge. See the registration card for warranty terms. If the warranty has lapsed, the meter will be repaired and returned for a fixed fee.

To locate an authorized service center, call Fluke using any of the phone numbers listed below, or visit us on the



Replaceable Parts

Note

 *When servicing the meter, use only the replacement parts specified.*

Replaceable parts are shown in Figure 5 and listed in Table 7. To order replacement parts in the USA, call 1-800-526-4731. To order outside the USA, contact the nearest Service Center.

Table 7. Replaceable Parts

Item	Description	Fluke Part Number	Quantity
BT1	Battery, 9V	614487	1
F1 	Fuse, F44/100A, 1000 VAC/DC	943121	1
F2 	Fuse, F11A, 1000 VAC/DC	943118	1
H1	Screw, Case	832246	3
MP1	Foot, Non-Skid	824466	2
MP2	O-Ring, Input Receptacle	831933	1
TM1	Users Manual, Fluke 87 (English)	834192	1
TM2	Users Manual, Fluke 87 (International)	834200	—
TM3	Service Manual, CAT III labeled meters	617826	—
	all other meters	834168	—
TM4	Quick Reference Guide, Fluke 80 Series	844290	1
TL20**	Industrial Test Lead Set (Optional)		—
TL75**	Test Lead Set		1
C81Y**	Holster, Yellow		1
C81G**	Holster, Gray (Optional)		—
C25**	Carrying Case, Soft (Optional)		—
 To ensure safety, use exact replacement only. ** Items marked with two asterisks are Fluke accessories and are available from you authorized Fluke distributor.			

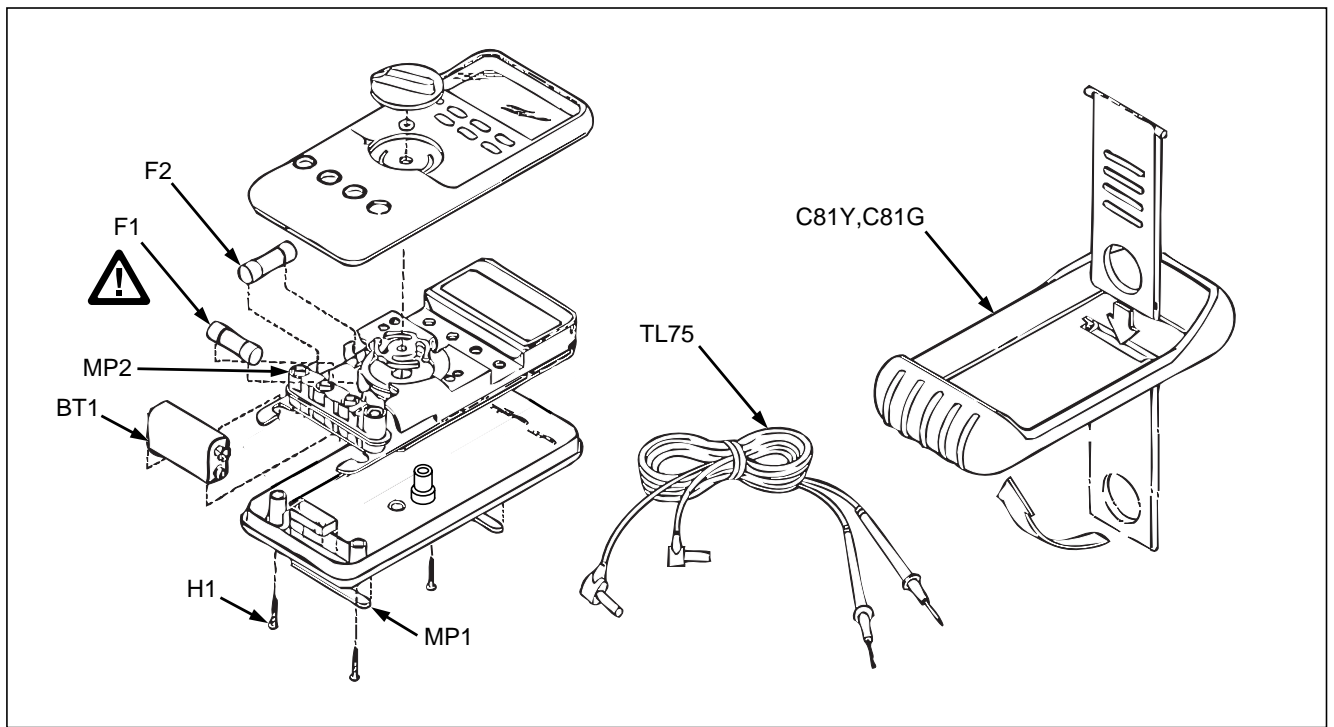

Figure 5. Replaceable Parts

ep5f.eps

Specifications

Function	Range	Resolution	Accuracy*			
			50 Hz - 60 Hz	45 Hz - 1 kHz	1 kHz - 5 kHz	5 kHz - 20 kHz***
~ V †	400.0 mV	0.1 mV	±(0.7% + 4)	±(1.0% + 4)	±(2.0% + 4)	±(2.0% + 20)
	4.000V	0.001V	±(0.7% + 2)	±(1.0% + 4)	±(2.0% + 4)	±(2.0% + 20)
	40.00V	0.01V	±(0.7% + 2)	±(1.0% + 4)	±(2.0% + 4)	±(2.0% + 20)
	400.0V	0.1V	±(0.7% + 2)	±(1.0% + 4)	±(2.0% + 4)‡	unspecified
	1000v	1V	±(0.7% + 2)	±(1.0% + 4)**	unspecified	unspecified

* Accuracy is given as ±[% of reading] + [number] + [number of least significant digits] at 18°C to 28°C, with relative humidity up to 90%, for a period of one year after calibration. In the 4 ½-digit mode, multiply the number of least significant digits (counts) by 10. AC conversions are ac-coupled, true rms responding, calibrated to the rms value of a sine wave input, and valid from 5% to 100% of range. AC crest factor can be up to 3 at full scale, 6 at half scale. For non-sinusoidal wave forms add -(2% Rdg +2% Fs) typical, for a crest factor up to 3.

** Below 10% of range, add 16 counts.

*** Below 10% of range, add 6 digits.

† The Fluke 87 is a True-RMS responding meter. The meter will display a reading (typically <25 digits) when the input leads are shorted together in the AC functions which is caused by internal amplifier noise. The accuracy on the Fluke 87 is not significantly affected by this internal offset when measuring inputs that are within 5% to 100% of the selected range. When the RMS value of the two values (5% of range and internal offset) is calculated, the effect is minimal as shown in the following example where 20.0 = 5% of 400 mV range, and 2.5 is the internal offset.

$$\text{RMS} = \text{SQRT}[(20.0)^2 + (2.5)^2] = 20.16$$

If you use the REL function to zero the display when using the AC functions, a constant error that is equal to the internal offset will result.

‡ Frequency range: 1 kHz to 2.5 kHz.

Specifications (cont)

Function	Range	Resolution	Accuracy*			
\bar{V}	4.000V	0.001V	$\pm(0.1\% + 1)$			
	40.00 V	0.01 V	$\pm(0.1\% + 1)$			
	400.0 V	0.1 V	$\pm(0.1\% + 1)$			
	1000 V	1 V	$\pm(0.1\% + 1)$			
\overline{mV}	400.0 mV	0.1 mV	$\pm(0.1\% + 1)$			
Ω (nS)	400.0 Ω	0.1 Ω	$\pm(0.2\% + 2)^{**}$			
	4.000 k Ω	0.001 k Ω	$\pm(0.2\% + 1)$			
	40.00 k Ω	0.01 k Ω	$\pm(0.2\% + 1)$			
	400.0 k Ω	0.1 k Ω	$\pm(0.6\% + 1)$			
	4.000 M Ω	0.001 M Ω	$\pm(0.6\% + 1)$			
	40.00 M Ω	0.01 M Ω	$\pm(1\% + 3)$			
	40.00 nS	0.01 nS	$\pm(1\% + 10)$			
* See page 36 for a complete explanation of this notation.						
** When using the REL Δ function to compensate for offsets.						
Typical Ohms Short Circuit Current						
Range	400	4k	40k	400k	4M	40M
Current	200 μ A	80 μ A	12 μ A	1.4 μ A	.2 μ A	.2 μ A

Specifications (cont)

Function	Range	Resolution	Accuracy***	
Capacitance	5.00 nF	0.01 nF	±(1% + 3)	
	0.0500 µF	0.0001 µF	±(1% + 3)	
	0.500 µF	0.001 µF	±(1% + 3)	
	5.00 µF	0.01 µF	±(1.9% + 3)	
Diode Test	3.000V	0.001V	±(2% + 1)	

Function	Range	Resolution	Accuracy*	Burden Voltage (typical)
mA † A~ (45 Hz to 2 kHz)	40.00 mA	0.01 mA	±(1.0% + 2)	1.8 mV/mA
	400.0 mA	0.1 mA	±(1.0% + 2)	1.8 mV/mA
	4000 mA	1 mA	±(1.0% + 2)	0.03 V/A
	10.00A††	0.01A	±(1.0% + 2)	0.03 V/A
mA A[∞]	40.00 mA	0.01 mA	±(0.2% + 2)	1.8 mV/mA
	400.0 mA	0.1 mA	±(0.2% + 2)	1.8 mV/mA
	4000 mA	1 mA	±(0.2% + 2)	0.03 V/A
	10.00 A††	0.01A	±(0.2% + 2)	0.03 V/A

*** With film capacitor or better, using Relative mode to zero residual.
† See page 34 for a complete explanation of this notation.
†† 10A continuous, 20A for 30 seconds maximum. ⚠

Specifications (cont)

Function	Range	Resolution	Accuracy	Burden Voltage (typical)
\sim † μA (45 Hz to 2 kHz)	400.0 μA	0.1 μA	$\pm(1.0\% + 2)$	100 $\mu\text{V}/\mu\text{A}$
	4000 μA	1 μA	$\pm(1.0\% + 2)$	100 $\mu\text{V}/\mu\text{A}$
$\overline{\text{—}}$ μA	400.0 μA	0.1 μA	$\pm(0.2\% + 3)$	100 $\mu\text{V}/\mu\text{A}$
	4000 μA	1 μA	$\pm(0.2\% + 2)$	100 $\mu\text{V}/\mu\text{A}$

Function	Range	Resolution	Accuracy
Frequency (0.5 Hz to 200 kHz, pulse width >2 μs)	199.99	0.01 Hz	$\pm(0.005\% + 1)$
	1999.9	0.1 Hz	$\pm(0.005\% + 1)$
	19.999 kHz	0.001 kHz	$\pm(0.005\% + 1)$
	199.99 kHz	0.01 kHz	$\pm(0.005\% + 1)$
	>200 kHz	0.1 kHz	Unspecified

† See page 36 for a complete explanation of this notation.

Specifications (cont)

Frequency Counter Sensitivity and Trigger Level			
Input Range	Minimum Sensitivity (RMS Sinewave)		Approximate Trigger Level (DC Voltage Function)
(Maximum input for specified accuracy = 10X Range or 1000V)	5 Hz - 20 kHz	0.5 Hz - 200 kHz	
400 mV dc	70 mV (to 400 Hz)	70 mV (to 400 Hz)	40 mV
400 mV dc	150 mV	150 mV	—
4V	0.3V	0.7V	1.7V
40V	3V	7V (≤ 140 kHz)	4V
400V	30V	70V (≤ 14.0 kHz)	40V
1000V	300V	700V (≤ 1.4 kHz)	400V

Duty Cycle 0.0 to 99.9%

Accuracy: Within $\pm(0.05\%$ per kHz + 0.1%) of full scale for a 5V logic family input on the 4V dc range.

 Within $\pm((0.06 \times \text{Voltage Range}/\text{Input Voltage}) \times 100\%)$ of full scale for sine wave inputs on ac voltage ranges.

Specifications (cont)

Function	Overload Protection†	Input Impedance (nominal)	Common Mode Rejection Ratio (1 k Ω unbalance)	Normal Mode Rejection	
\bar{V}	1000V rms	10 M Ω <100 pF	>120 dB at dc, 50 Hz or 60 Hz	>60 dB at 50 Hz or 60 Hz	
\bar{mV}	1000V rms	10 M Ω <100 pF	>120 dB at dc, 50 Hz or 60 Hz	>60 dB at 50 Hz or 60 Hz	
\tilde{V}	1000V rms	10 M Ω <100 pF (ac-coupled)	>60 dBc dc to 60 Hz		
Ω	1000V rms	Open Circuit Test Voltage	Full Scale Voltage		Short Circuit Current
			To 4.0 M Ω	40 M Ω or nS	
		<1.3V dc	<450 mV dc	<1.3V dc	<200 μ A
Diode Test	1000V rms	<3.9V dc	3.000V dc		0.6 mA typical

† 10⁶V Hz max

Specifications (cont)

MIN MAX Recording	Nominal Response	Accuracy
	100 ms to 80% (DC Functions)	Specified accuracy ± 12 digits for changes > 200 ms in duration.
	120 ms to 80% (AC Functions)	Specified accuracy ± 40 digits for changes > 350 ms and inputs $> 25\%$ of range.
	1s	Same as specified accuracy for changes > 2 seconds in duration.
	1 ms	Specified accuracy ± 40 digits for changes > 1 ms in duration. (± 100 digits typical for mv, 400 μ A dc, 40 mA dc, 4000 mA dc.)
Δ Fuse Protection		Maximum Voltage between any Terminal and Earth Ground
mA or μ A A	44/100A, 1000V FAST Fuse 11A, 1000V FAST Fuse	1000V rms

Specifications (cont)

Display	Digital: 4000 counts updates 4/sec 19,999 counts (4½-digit mode), updates 1/sec Analog: 4 x 32 segments (equivalent to 128), updates 40/sec Frequency: 19,999 counts, updates 3/sec @ >10 Hz Backlight: On for 68 seconds when selected.
Operating Temperature	-20°C to 55°C
Storage Temperature	-40°C to 60°C
Temperature Coefficient	0.05 x (specified accuracy)/ °C (<18°C or >28°C)
Electromagnetic Compatibility	In an RF field of 1 V/m on all ranges and functions except capacitance: Total Accuracy = Specified Accuracy + 2.5% of range. Capacitance not specified. Performance above 1 V/m is not specified.
Relative Humidity	0% to 90% (0°C to 35°C) 0% to 70% (35°C to 55°C)
Battery Type	9V, NEDA 1604 or 6F22 or 006P
Battery Life	400 hrs typical with alkaline
Shock Vibration	Per MIL-T-28800 for a Class 2 instrument
Size (HxWxL)	1.25 in x 3.41 in x 7.35 in (3.1 cm x 8.6 cm x 18.6 cm)
With Holster and Flex-Stand:	2.06 in x 3.86 in x 7.93 in (5.2 cm x 9.8 cm x 20.1 cm)
Weight	12.5 oz (355g)
With Holster and Flex-Stand:	22.0 oz (624g)
Safety	Designed to comply with IEC 1010-1 as a 1000V, CAT III instrument (see pg.2 for definition of CAT III). UL listed to UL3111, TUV licensed to EN 61010-1, CSA 22.2
	No. 1010.1:1992. 